

SMITHERMAN  
6/17/76

on base  
40  
5/10/76

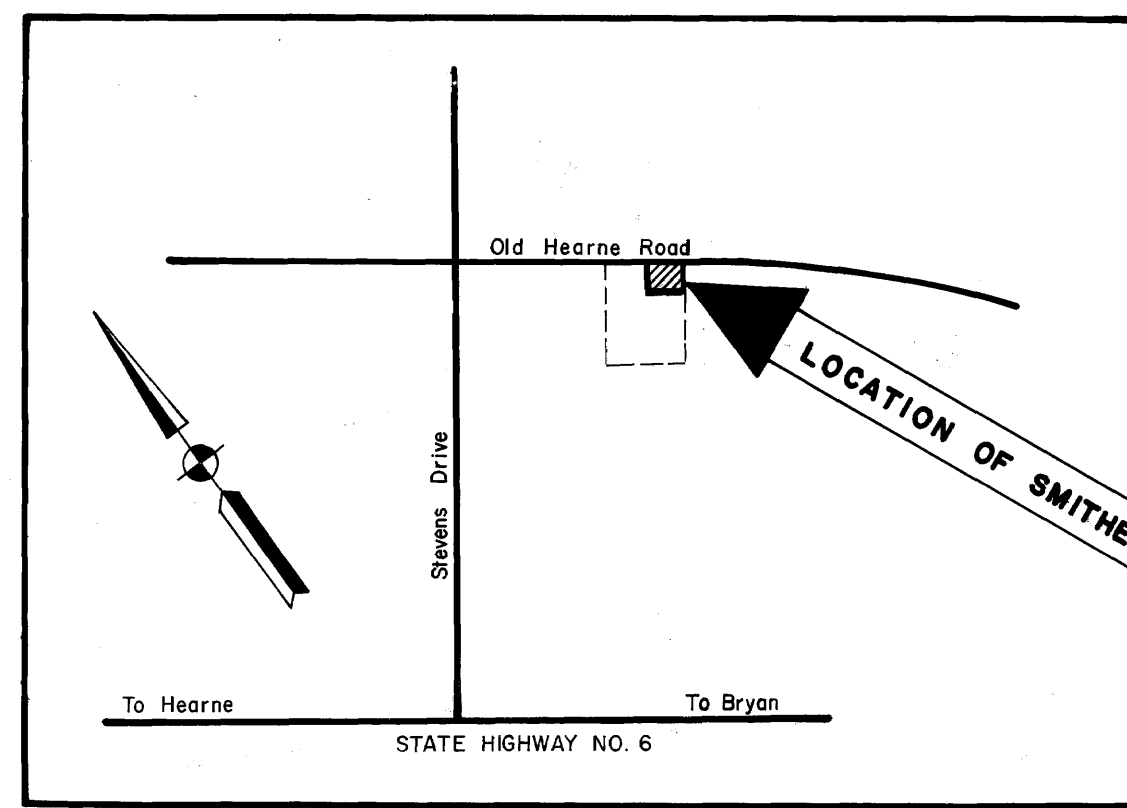

**VICINITY MAP**

N.T.S.

Now Or Formerly  
Roger Power  
26 Acre Tract

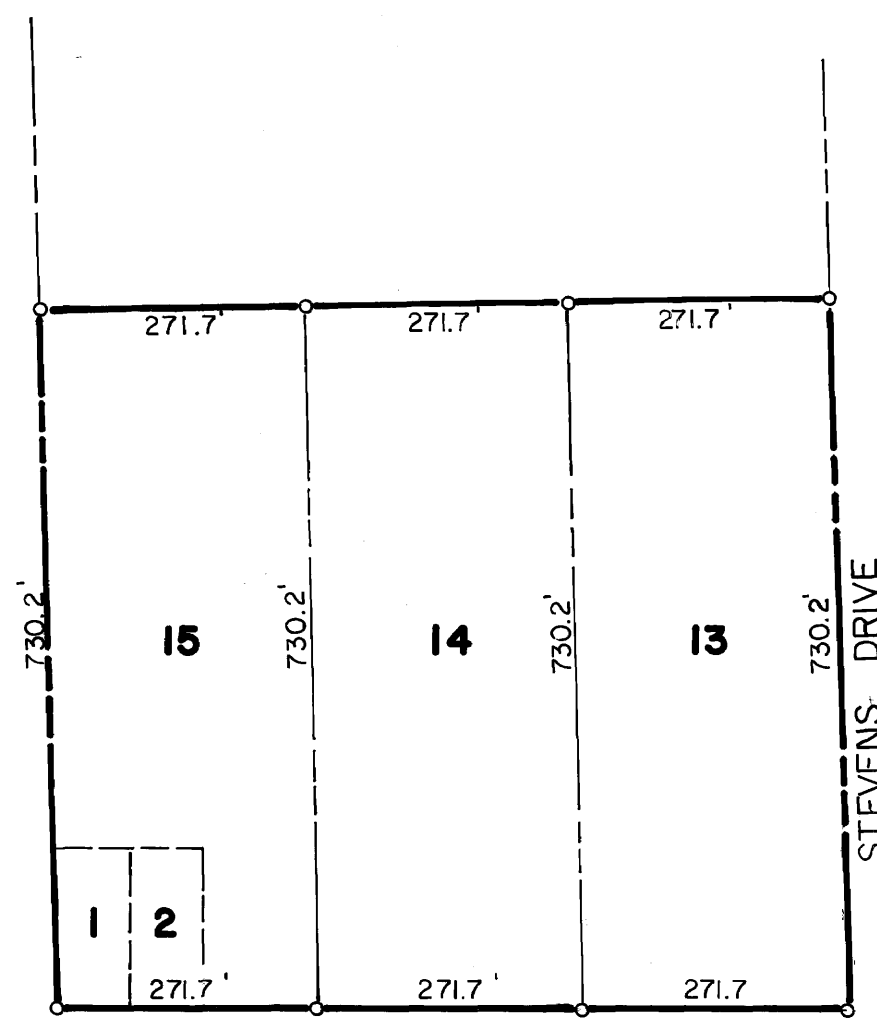

**OLD HEARNE ROAD**

**VACATING PLAT**

Scale: 1" = 200'

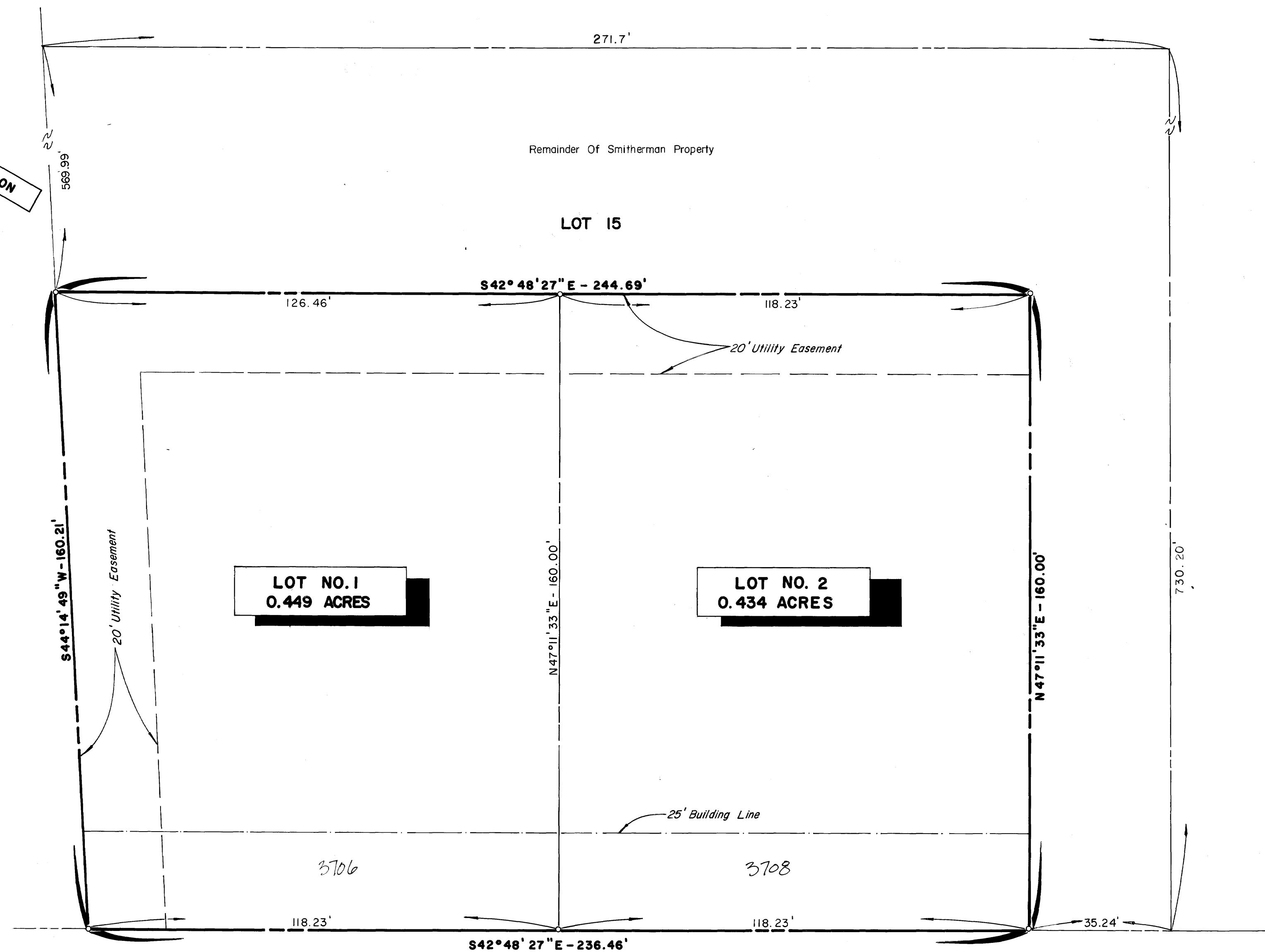

**OLD HEARNE ROAD**

**RE-SUBDIVISION PLAT**

Scale: 1" = 20'

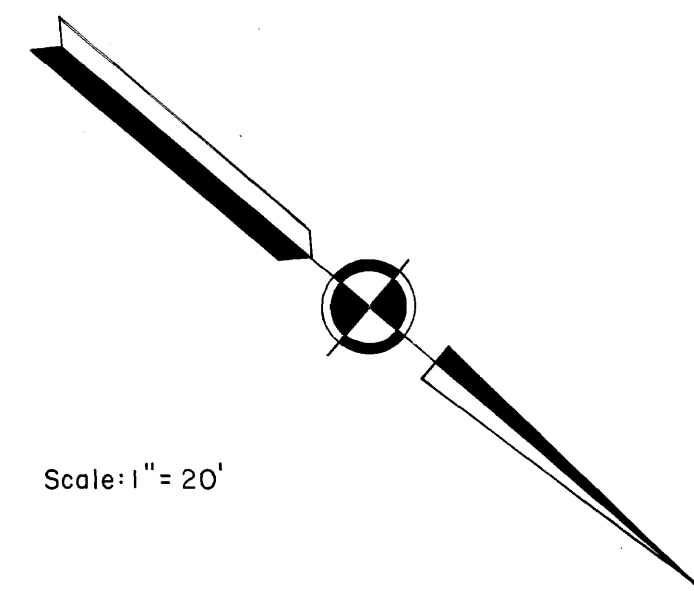

Scale: 1" = 20'

**CERTIFICATE OF OWNERSHIP AND DEDICATION:**

I (we) Cleo Smitherman

Own (s) and Developer(s) of the land shown on this plat, and designated herein as the Smitherman Addition, Re-Subdivision of Lot 15 to the City of Bryan, Texas, and whose name(s) is/are subscribed hereto, hereby dedicate to the use of the public forever all streets, alleys, parks, water courses, drains, easements and public places thereon shown for the purpose and consideration therein expressed:

Cleo Smitherman

STATE OF TEXAS  
COUNTY OF BRAZOS

Before me, the undersigned authority, on this day personally appeared CLEO SMITHERMAN known to me to be the person (s) whose name (s) is/are subscribed to the foregoing instrument, and acknowledged to me that he/they executed the same for the purpose and consideration therein stated.

Given under my hand and seal on this 21 day of May

1976

(seal)

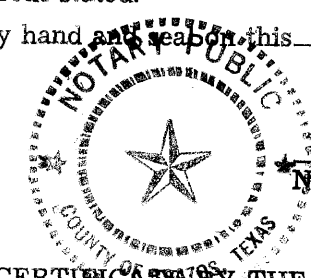

Jerry Bishop  
Notary Public, Brazos County, Texas

**CERTIFICATE BY THE COUNTY CLERK:**

STATE OF TEXAS  
COUNTY OF BRAZOS

I, Frank Boristie County Clerk, in and for the said County, do hereby certify that this plat together with its certification of authentication was filed for record in my office the 21 day of May

1976 in the Deed Records of Brazos County, Volume 302, Page 206.

Frank Boristie  
County Clerk, Brazos County, Texas

**APPROVAL OF THE PLANNING COMMISSION:**

I, D.D. Williamson Chairman of the City Planning Commission of the City of Bryan, State of Texas, hereby certify that the attached plat was duly filed for approval with the City Planning Commission of the City of Bryan on the 17 day of May, 1976 and same was duly approved on the 20 day of May, 1976 by said Commission.

D.D. Williamson  
Chairman, City Planning Commission  
Bryan, Texas

**CERTIFICATE BY THE CITY PLANNER:**

I, the undersigned, City Planner of the City of Bryan, hereby certify that this division plat conforms to all requirements of the subdivision regulations of the City of Bryan, Texas.

Hubert D. Nelson  
City Planner  
City of Bryan, Texas

**CERTIFICATION BY THE ENGINEER:**

STATE OF TEXAS  
COUNTY OF BRAZOS

I, Jerry Bishop, Registered Professional Engineer No. 37426 in the State of Texas, hereby certify that proper engineering consideration has been given this plat.

Jerry Bishop  
Registered Professional Engineer

**CERTIFICATION OF THE SURVEYOR:**

STATE OF TEXAS  
COUNTY OF BRAZOS

I, Jerry Bishop, Registered Professional Engineer No. 37426 in the State of Texas, hereby certify that this plat is true and correct and was prepared from an actual survey of the property made under my supervision on the ground.

Jerry Bishop  
Registered Professional Engineer

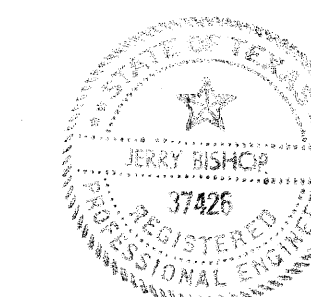
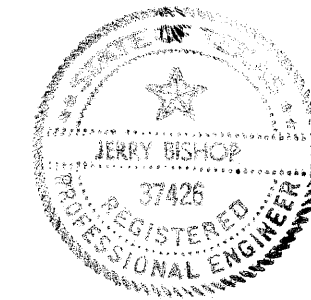

**GENERAL NOTES:**

- 1) Minimum Sidewalk Setback is Five (5) Feet.
- 2) Denotes Iron Rod.
- 3) Iron Rods Set At All Property Corners.

THE OWNER OF THE LAND SHOWN ON THIS PLAT AND WHOSE NAME IS SUBSCRIBED HERETO, AND IN PERSON OR THROUGH A DULY AUTHORIZED AGENT, HEREBY DECLARES A PORTION OF LOT 15, WILLIAMS SUBDIVISION TO THE CITY OF BRYAN, TEXAS; TO BE VACATED AND TO ESTABLISH THE AREA VACATED AS LOTS 1 & 2, WILLIAMS SUBDIVISION, TO THE CITY OF BRYAN, TEXAS.

**SMITHERMAN ADDN.**

**FINAL PLAT**

**A RE-SUBDIVISION OF A PORTION OF LOT 15**

**WILLIAMS SUBDIVISION**  
BRYAN, BRAZOS COUNTY, TEXAS

SCALE: 1" = 20'  
MAY, 1976

PREPARED BY: BRYAN ENGINEERING & SURVEYING CORP.  
1504 CAVITT AVENUE  
P.O. BOX 3944  
BRYAN, TEXAS 77801